

Applications of Common Information Model and Feeder Voltage Sensor to High-penetration Photovoltaic Systems

Te-Tien Ku,^{1*} Chia-Hung Lin,¹ Chao-Shun Chen,² Yih-Der Lee,³
Jheng-Lun Jiang,³ Cheng-Yu Chen,³ and Chen-Min Chan³

¹National Kaohsiung University of Science and Technology, Kaohsiung 807618, Taiwan

²I-Shou University, Kaohsiung 840203, Taiwan

³Institute of Nuclear Energy Research, Taoyuan 325207, Taiwan

(Received July 4, 2022; accepted August 29, 2022)

Keywords: common information model, transformer terminal unit, feeder voltage sensor, renewable energy autonomous control

In this study, we design and install a transformer terminal unit (TTU) with a voltage sensor and apply data exchange technologies using a common information model (CIM) to measure the voltages at the ends of distribution feeders. The object-oriented CIM is used to transfer the facilities of the distribution mapping management system to a class represented by the relationship between association, aggregation, and inheritance. We propose a simple object access protocol (SOAP)-based architecture to improve the reliability and security of the data transfer. The proposed CIM is applied to the data transfer of the TTU to monitor the voltages at the ends of the feeders and to achieve supervisory control and data acquisition of the facilities in distribution systems with high-penetration photovoltaic power.

1. Introduction

In recent years, increasing emissions of greenhouse gases such as carbon dioxide and nitrogen oxides have caused global warming. To reduce the greenhouse effect, renewable energy sources such as solar and wind power generation are being promoted to reduce traditional thermal power generation. To achieve the goal of 20% renewable energy in Taiwan, photovoltaic (PV) and wind power generators with capacities of 20 and 7.7 GWp, respectively, will be installed by 2025. However, the high penetration of renewable sources causes voltage variation and affects the power quality of distribution systems. To maintain the power quality of distribution systems, smart inverters are installed in renewable energy systems, and embedded autonomous control, such as reactive power/voltage [Q(V)] and active power/voltage [P(V)] control, is performed to reduce the voltage variation when the voltages of points of common coupling are larger than the setting point (1.05 pu). A voltage measurement unit at the end of a feeder is very important to determine the voltage to decide the setting point of each smart inverter. To monitor the voltage of a feeder, in this study, we designed and installed a novel

*Corresponding author: e-mail: ttku@nkust.edu.tw
<https://doi.org/10.18494/SAM4028>

transformer terminal unit (TTU) on a distribution transformer, not only to measure the voltage at the end of a feeder but also to measure the current by using a current transformer (CT) to collect its power parameters.

The TTU includes a sampling circuit to sense voltage and current signals via the secondary sides of the distribution transformer and CT. To collect the transformer voltage, current, and power parameters, a long-range (LoRa) communication module is embedded in the TTU to transmit information to a data concentrator unit (DCU) where the information is recorded in the database of the DCU. When the DCU has collected all of the information of the corresponding TTU, the information is sent via 4G mobile communication to the master station and displayed on the screen of a supervisory control and data acquisition (SCADA) system. To maintain the power quality of distribution systems, Taiwan Power Company (Taipower) has already implemented a distribution renewable energy advanced management system (DREAMS) to collect all the information on renewable energy generation and control smart inverters via a communication gateway. The communication gateway receives autonomous commands and sends them to the smart inverters to maintain the feeder voltage. The setting points of Q(V) and P(V) are determined to adjust the operations of the smart inverters. To exchange information between the master station, DREAMS, and the distribution mapping management system (DMMS), a common information model (CIM) is employed to provide a common definition of management information among these systems.^(1,2) The data of the measured voltage, current, power parameters, and Q(V) and P(V) setting points for the TTU and PV gateway are defined as the CIM in the study. To improve the reliability and security of the data transfer between management systems, a simple object access protocol (SOAP) is also proposed in this study to ensure that data are not missing or tampered with during communication congestion or intrusion.^(3,4) The communication flow among the management systems in this study is shown in Fig. 1.

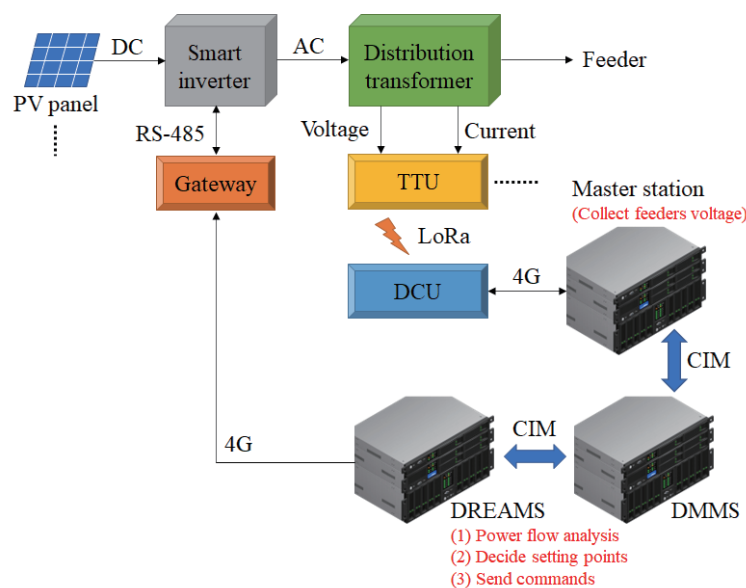

Fig. 1. (Color online) Communication architecture of CIM.

In Sect. 2, we present the circuits of the TTU used to measure the voltage and current of the distribution transformer. Section 3 describes the CIM of the TTU and the PV gateway used to exchange information between management systems. Section 4 discusses the field installation of the TTU in Taipower distribution systems to measure the feeder voltage and the use of the CIM to exchange information. Finally, conclusions are given in Sect. 5.

2. Design of Transformer Terminal Unit

The TTU is designed and installed on the secondary side of a distribution transformer to measure the voltage of feeders and the power parameters of distribution transformers. The Xswitching power supply is embedded to convert AC 220 V to DC 12 V, and a low-dropout regulator is used to convert the circuit voltages to 5 and 3.3 V. The TTU includes a power measurement unit, data processing unit, and wireless communication unit. The architecture of the TTU is shown in Fig. 2. The hardware of the TTU developed in this study is shown in Fig. 3.

2.1 Power measurement unit

The power measurement unit is composed of voltage- and current-sampling circuits and a power measurement IC. The voltage signal is divided by resistors including a passive low-pass

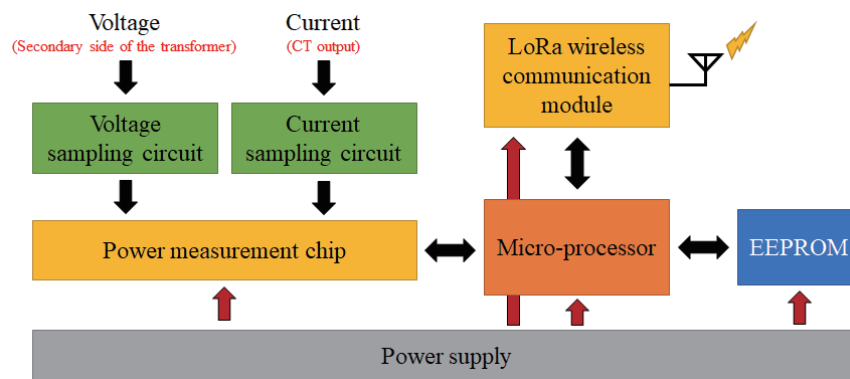

Fig. 2. (Color online) Architecture of the TTU.

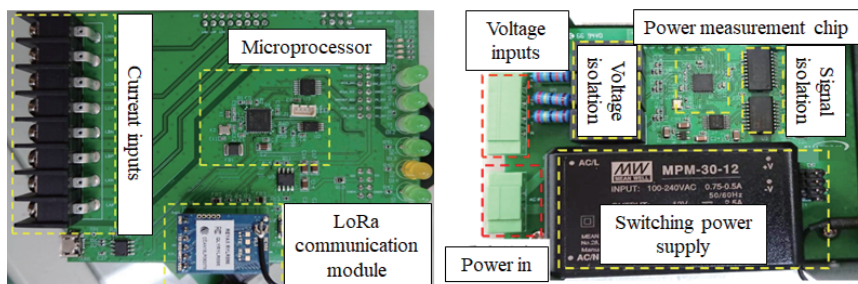

Fig. 3. (Color online) Hardware of the TTU.

filter (LPF) to reduce noise from the load-embedded switching power supply. The current signal is measured by a CT with a passive LPF. When the voltage and current signals pass through the sampling circuit, the input signals pass through a programmable gain amplifier (PGA) and a two-step Σ - Δ analog/digital converter (ADC) to convert the analog signal to a digital value based on the voltage reference. After sampling, holding, and quantifying, the signal that has passed through the LPF should be compensated because of the attenuation of passive components. A high-pass filter is used to reject the signal offset and then compensate for the phasor error, and the power measurement IC then calculates the root mean square (RMS) of the input signal V_{rms} using Eq. (1) after sampling the maximum value of V_m with N sample points within one cycle. The process flow of signal sampling is shown in Fig. 4.

$$V_{rms} = \sqrt{\frac{1}{N} \sum_{n=1}^N V_m(n)^2} \tag{1}$$

2.2 Data processing unit

The data processing unit comprises a microprocessor and an electrically erasable programmable read-only memory (EEPROM). The microprocessor communicates with a power measurement IC via a serial peripheral interface (SPI) to receive the measured raw data used to calculate RMS values of the voltage, current, and active/reactive power. The real-time measured data are recorded in the EEPROM and transmitted by LoRa communication to the DCU. The architecture of the data processing unit is shown in Fig. 5.

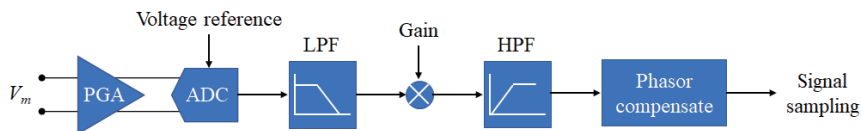

Fig. 4. (Color online) Process flow of signal sampling.

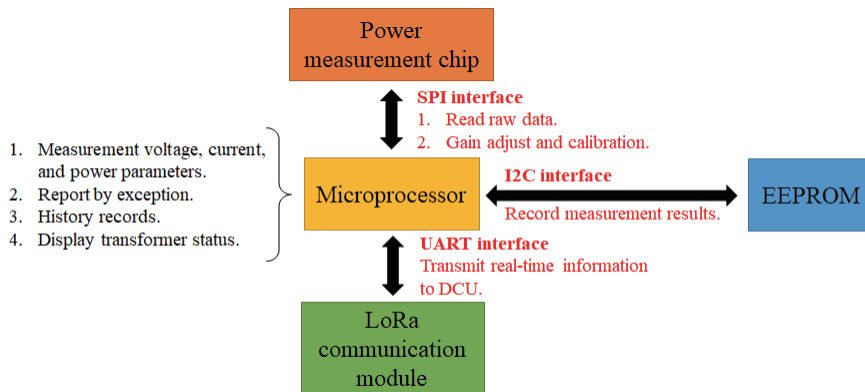

Fig. 5. (Color online) Architecture of the data processing unit.

2.3 Wireless communication unit

The LoRa communication module is embedded in the TTU to transmit data from the TTU to the DCU. The frequency, bandwidth, spreading factor, coding rate, parameters such as the network identification (ID), and the node address must be set for the module to provide wireless connectivity based on the LoRaWAN protocol. Figure 6 shows the communication processes between the TTU and the DCU.

3. Common Information Models of TTU and PV Gateway

In the study, CIMs are used to exchange data between systems such as the master stations, DMMS, and DREAMS. Descriptions of the resource description framework (RDF) and unified modeling language (UML) of the TTU are shown in Figs. 7 and 8, respectively.⁽⁵⁻⁷⁾ In Fig. 7, AnalogValue represents analog measurement values including voltage, current, active power, and reactive power, and AccumulatorValue represents the amounts of active and reactive energy consumption. The classes of BaseCapacity and PhaseCode are defined as the utilization rate and the phasor of a distribution transformer, respectively.⁽⁸⁾

When DREAMS executes the power flow of the distribution system and derives each setting of the renewable energy generation system, the CIM is also used for data exchange between DREAMS and the gateway of the PV system.^(9,10) The SetPoint class represents the setting points of the active power output control, power factor control, and autonomous control. The UML of the PV gateway in this study is shown in Fig. 9.

To ensure the reliability and security of data transfer, the SOAP is used to send data to the runtime and check the ID from the store. The runtime sends acknowledges (ACKs) to the application and stops sending data to the server when a duplicate ID is detected in the store. The runtime deletes the ID from the store when all the data between the sender and receiver have been exchanged. The data exchange by the SOAP is shown in Fig. 10.

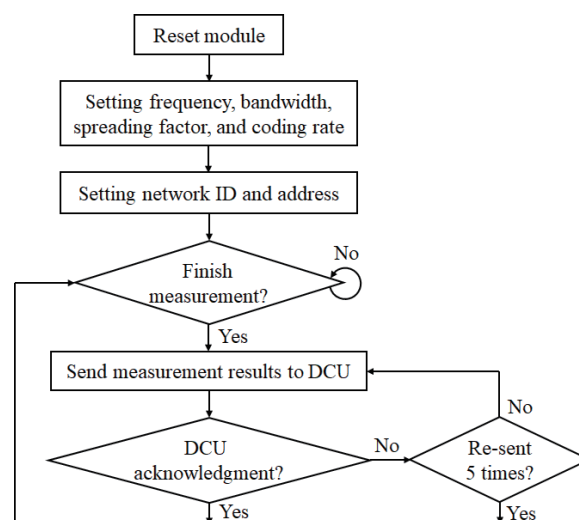

Fig. 6. Communication process of the LoRa module.

```

<rdfs:Class rdf:ID=" MeasurementValue" >
  <rdfs:label xml:lang="en"> MeasurementValue </ rdfs:label>
</rdfs:Class>
<rdfs:Class rdf:ID="AnalogValue" >
  <rdfs:label xml:lang="en"> AnalogValue</ rdfs:label>
  <rdfs:subClassOf rdf:resource="#MeasurementValue" />
</rdfs:Class>
<rdfs:Class rdf:ID="AccumulatorValue" >
  <rdfs:label xml:lang="en"> AccumulatorValue </ rdfs:label>
  <rdfs:subClassOf rdf:resource="#MeasurementValue" />
</rdfs:Class>
<rdf:Property rdf:ID=" MeasurementValue.timeStamp">
  <rdfs:label xml:lang="en"> timeStamp</ rdfs:label>
  <rdfs:domain resource="#MeasurementValue"/>
  <rdfs:range resource="#AbsoluteDateTime"/>
</rdf:Property>
<rdf:Property rdf:ID=" MeasurementValue.sensorAccuracy">
  <rdfs:label xml:lang="en">sensorAccuracy</ rdfs:label>
  <rdfs:domain resource="#MeasurementValue"/>
  <rdfs:range resource="#PerCent"/>
</rdf:Property>
<rdf:Property rdf:ID=" AnalogValue.LineVoltageVX1">
  <rdfs:label xml:lang="en"> LineVoltageVX1</ rdfs:label>
  <rdfs:domain resource="# AnalogValue"/>
  <rdfs:range resource="#Float"/>
</rdf:Property>
<rdf:Property rdf:ID=" AnalogValue.LineCurrentIX1">
  <rdfs:label xml:lang="en"> LineCurrentIX1</ rdfs:label>
  <rdfs:domain resource="# AnalogValue"/>
  <rdfs:range resource="#Float"/>
</rdf:Property>
<rdf:Property rdf:ID=" AnalogValue.ActivePowerP1">
  <rdfs:label xml:lang="en"> ApparentPowerP1</ rdfs:label>
  <rdfs:domain resource="# AnalogValue"/>
  <rdfs:range resource="#Float"/>
</rdf:Property>
<rdf:Property rdf:ID=" AccumulatorValue.KWHplus">
  <rdfs:label xml:lang="en"> KWHplus </ rdfs:label>
  <rdfs:domain resource="# AccumulatorValue"/>
  <rdfs:range resource="#Float"/>
</rdf:Property>
<rdf:Property rdf:ID=" AccumulatorValue.KWHminus">
  <rdfs:label xml:lang="en"> KWHminus </ rdfs:label>
  <rdfs:domain resource="# AccumulatorValue"/>
  <rdfs:range resource="#Float"/>
</rdf:Property>
  
```

Fig. 7. RDF of the TTU.

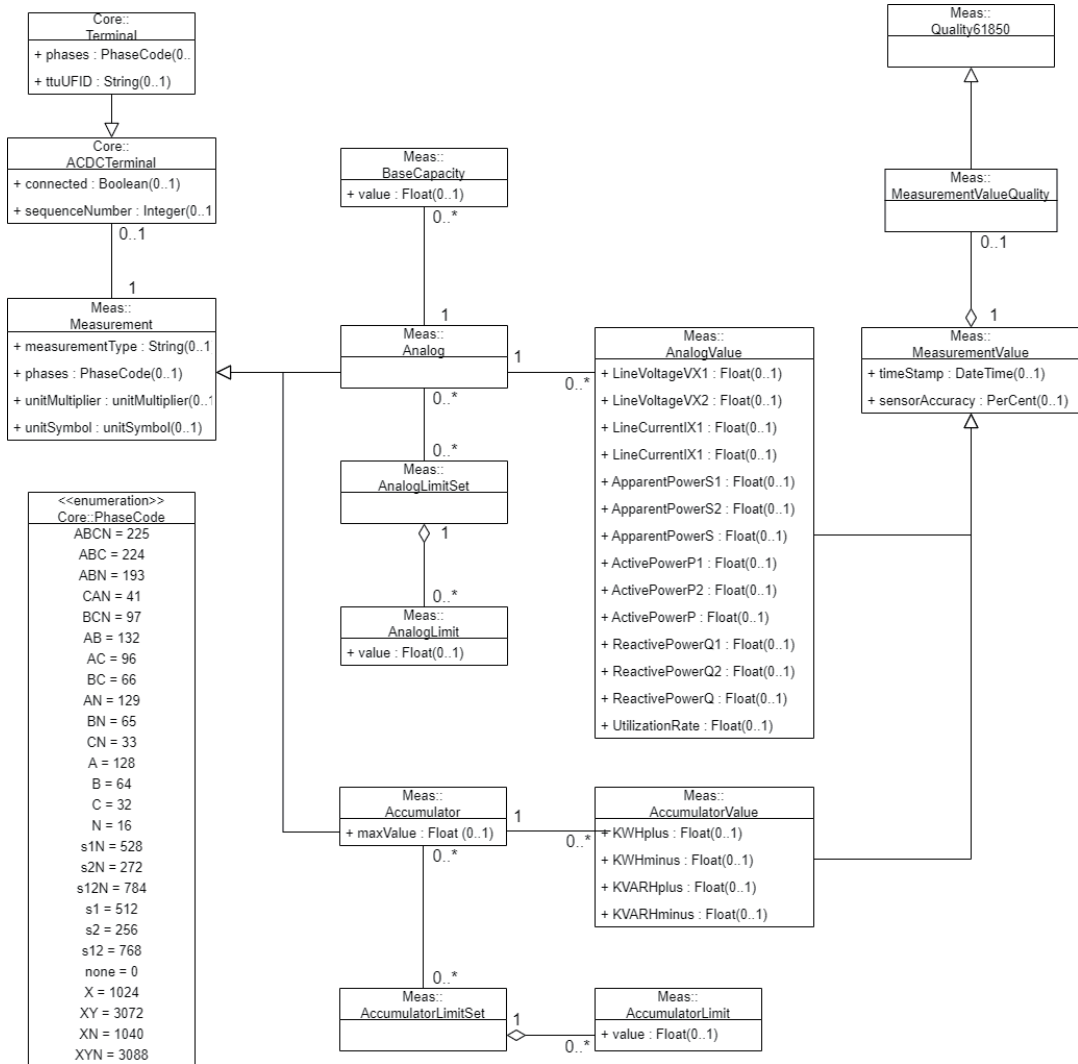

Fig. 8. UML of the TTU.

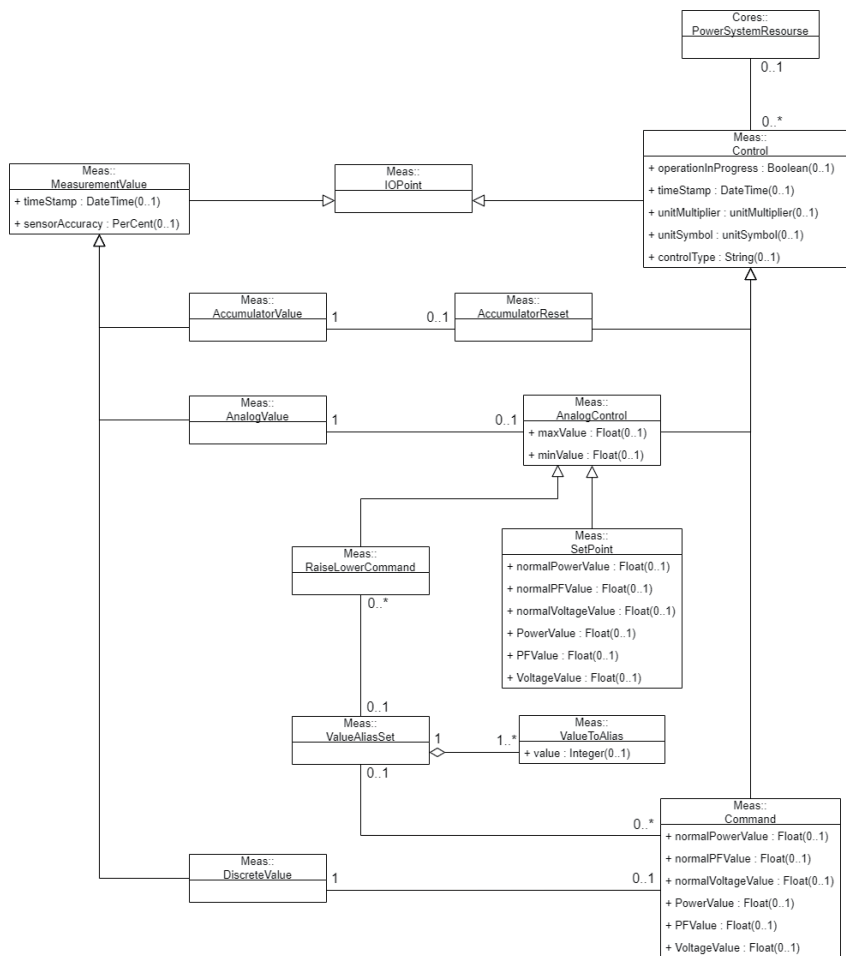

Fig. 9. (Color online) UML of the PV gateway.

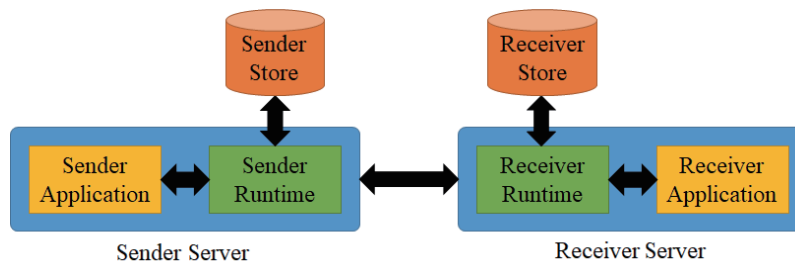

Fig. 10. (Color online) Data exchange of the SOAP.

4. Field Test and Data Exchange Using CIM

In the study, the particle feeders of Taipower in suburban and urban areas are selected for the installations of TTUs. The hourly received signal strength indicator (RSSI) is used to verify the performance of LoRa wireless communication. At the same time, the voltage of the secondary side of the distribution transformer is measured and reported to the DCU to execute the

autonomous control of the smart inverters of PV systems along the feeders. The field installations of the TTU and DCU are shown in Fig. 11.

Figure 12 shows the hourly voltages and RSSIs of a selected transformer of the feeder in a suburban area over one day. The maximum voltage is 12.23 kV at 7 a.m. and the minimum voltage is 11.68 kV at 3 p.m. The voltage variation is due to changes in the load of commercial customers and the intermittency of renewables. The distance between the TTU and the corresponding DCU is 1.66 km, and the daily RSSI is approximately -105 dBm to ensure good wireless communication in the suburban area when the RSSI is larger than the LoRa module limit of -120 dBm.

Figure 13 shows the hourly voltages and RSSIs of a selected transformer of the feeder in an urban area over one day to verify the performance of LoRa wireless communication. The

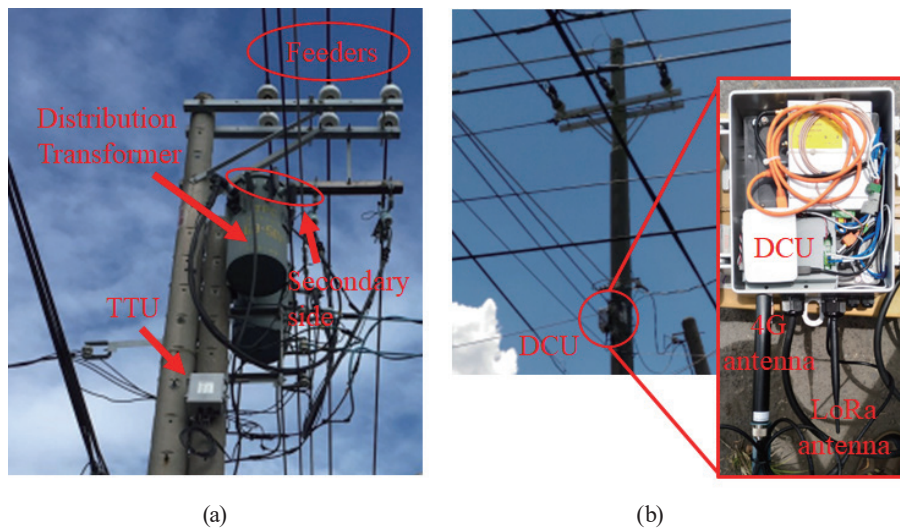

Fig. 11. (Color online) Field installations of TTU and DCU. (a) Installation of TTU. (b) Installation of DCU.

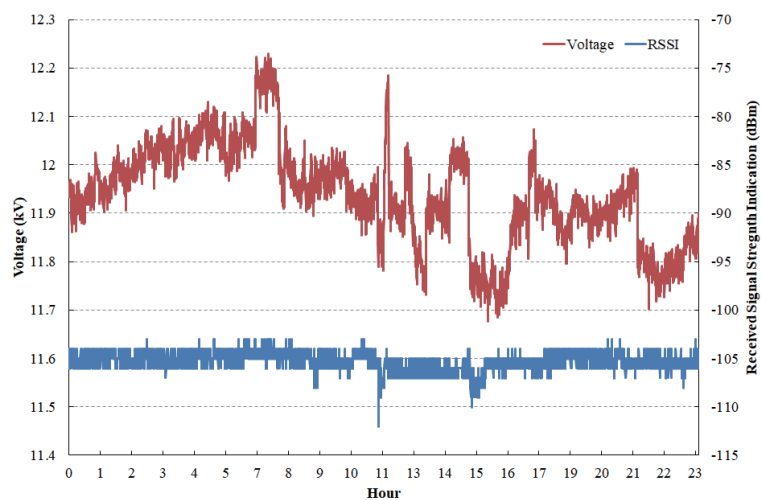

Fig. 12. (Color online) Hourly voltage and RSSI in suburban area over one day.

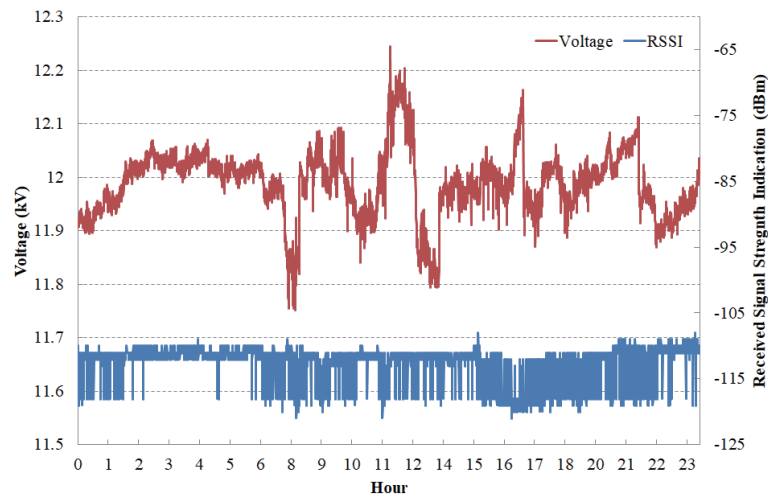

Fig. 13. (Color online) Hourly voltage and RSSI in urban area over one day.

maximum voltage is 12.25 kV at 11 a.m. and the minimum voltage is 11.75 kV at 8 a.m. The voltage variation is due to the changes in the load of commercial customers. The distance between the TTU and the corresponding DCU is 1.55 km and the RSSI is close to the limit of -120 dBm because of some obstructions in the wireless path from the TTU to the DCU. The RSSI from 2 a.m. to 5 a.m. is better than that of the daytime period because personal activity and mobile devices interfere with the wireless signals, reducing the communication success rate between the TTU and the DCU.

The real-time feeder voltages, active power, and reactive power of the test distribution transformer are transmitted to the master station via a 4G mobile communication system. Distributed network protocol 3 (DNP3) is used for communications between DCUs and the master station. The master station records all information in the real-time and history databases. The retrieved information from the real-time database is converted to XML format by the CIM.⁽¹¹⁾ The real-time data, such as the feeder voltage, active power, and reactive power of a distribution transformer, are exchanged with DREAMS, with the CIM used to execute power flow analysis for each renewable energy generation system and to derive the settings of the smart inverters for Q(V) and P(V) control.^(12,13) The commands of the settings are sent to the PV gateway and then transmitted to the smart inverters. To prevent the overvoltage problem caused by the generation of excessive PV power, the smart inverters of PV systems must perform autonomous control by changing the operational mode from maximum power point tracking (MPPT) to the open-circuit voltage of the PV panel.^(14,15) Figures 14 and 15 show the XML rules of the TTU and PV gateway in this study, respectively.

DREAMS sends the commands to the PV gateway using the CIM to adjust the settings of the smart inverters according to the measured data of the TTUs and the results of power flow analysis. Figure 16 illustrates the voltage and the reactive power before and after the PV system executes the command to adjust the settings of the smart inverter. The voltage of the secondary side of the distribution transformer is 234.29 V before executing the command. The voltage

```

<cim:AnalogValue rdf: ID="_TTU1ID">
<cim: AnalogValue.LineVoltageVX1>118</cim: AnalogValue.LineVoltageVX1>
<cim: AnalogValue.LineVoltageVX2>118</cim: AnalogValue.LineVoltageVX2>
<cim: AnalogValue.LineCurentIX1>63</cim: AnalogValue.LineCurentIX1>
<cim: AnalogValue.LineCurentIX2>62</cim: AnalogValue.LineCurentIX2>
<cim: AnalogValue.ApparentPowerS>16</cim: AnalogValue.ApparentPowerS>
<cim: AnalogValue.ActivePowerP>16</cim: AnalogValue.ActivePowerP>
<cim: AnalogValue.ReactivePowerQ >16</cim: AnalogValue.ReactivePowerQ >
<cim:Measurement.Terminal rdf: resource="#_TransformerAID"/>
<cim:IdentifiedObject.description>renewable energy generation</cim:IdentifiedObject.description>
<cim:IdentifiedObject.name>TTU1</cim:IdentifiedObject.name>
</cim:AnalogValue >
<cim:Terminal rdf: ID="_TransformerAID">
<cim:Terminal.Measurement rdf: resource="#_TTU1ID">
<cim:Terminal.ConnectivityNode rdf: resource="#_Node1ID">
<cim:IdentifiedObject.name>TransformerA</cim:IdentifiedObject.name>
</cim:Terminal>

```

Fig. 14. XML rules of the TTU.

```

<cim: SetPoint rdf: ID="_PVG1ID">
<cim: SetPoint.normalPowerValue>499</ cim: SetPoint.normalPowerValue >
<cim: SetPoint.normalPFValue>0.98</ cim: SetPoint.normalPFValue >
<cim: SetPoint.normalVoltageValue>1.05</ cim: SetPoint.normalVoltageValue >
<cim: SetPoint.PowerValue>499</cim: SetPoint.PowerValue>
<cim: SetPoint.PFValue>0.98</cim: SetPoint.PFValue>
<cim: SetPoint.VoltageValue>1.05</cim: SetPoint. VoltageValue>
<cim: AnalogControl.maxValue>1.09<cim: AnalogControl.maxValue>
<cim: AnalogControl.minValue>1.05<cim: AnalogControl.minValue>
<cim: Control.operationInProgress>InProgress</cim: Control.operationInProgress>
<cim: Control.timeStamp>2022/06/01 13:30:05</cim: Control.timeStamp>
<cim: Control.UnitMultiplier>1</cim: Control. UnitMultiplier>
<cim: Control.UnitSymbol>1</cim: Control.UnitSymbol>
<cim:Control.IOPoint rdf: resource="#_TransformerAID"/>
<cim:IdentifiedObject.description>renewable energy control</cim:IdentifiedObject.description>
<cim:IdentifiedObject.name>PVG1</cim:IdentifiedObject.name>
</cim: SetPoint >

```

Fig. 15. XML rules of the PV gateway.

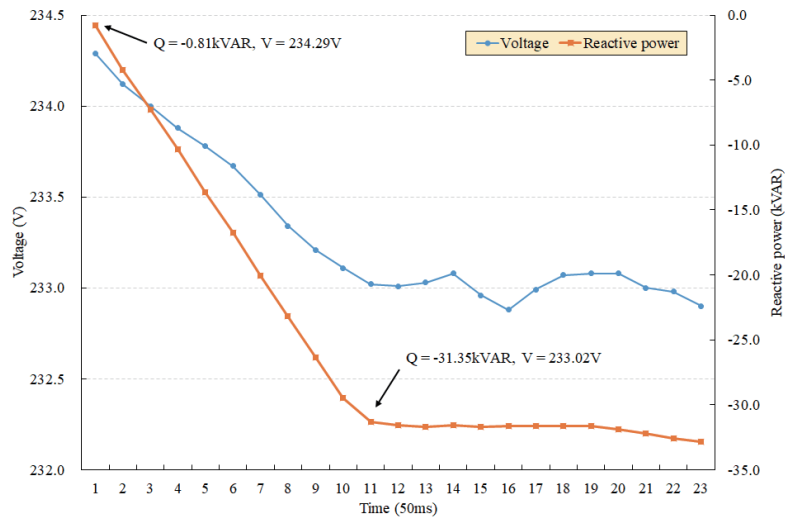

Fig. 16. (Color online) Response of the smart inverter.

decreases to 233.02 V and the reactive power increases from -0.81 to -31.35 kVAR after the PV gateway receives the command, and the lagging power factor is adjusted from 1.0 to 0.9.

5. Conclusions

We propose a CIM for data exchange among the master station, DMMS, and DREAMS to monitor the feeder voltage in high-penetration photovoltaic systems. The TTU is developed to measure the voltage, current, active power, and reactive power of a distribution transformer. LoRa and 4G wireless communication are used to collect all the measurement information and transmit it to the master station. The UML and RDF of the CIM for the TTU and the PV gateway are defined to manage data exchange between different applications and systems. The impact of a high penetration of renewable energy is analyzed using power flow software, and the setting of each PV smart inverter is then derived by an autonomous control strategy. DREAMS sends the commands to the PV gateway to adjust the power factor of each smart inverter. The results of a field test show that the quality of the service voltage for a distribution system with high PV penetration can be enhanced effectively by DREAMS to control the power factor in accordance with the real-time measurement of TTUs.

Acknowledgments

This work was supported in part by the Institute of Nuclear Energy Research, Atomic Energy Council of the Republic of China under Contract 111A011.

References

- 1 Common Information Model for Distribution (Electric Power Research Institute, 2008).
- 2 Common Information Model Harmonization and Implementation Examples (Electric Power Research Institute, 2011).
- 3 WP 2 - Innovative Distribution Grid Use Cases and Functions, Report on The Implementation of The CIM As The Reference Data Model for The Project (The UPGRID Consortium, 2015).
- 4 IEC61970-301:2021, Energy Management System Application Program Interface (EMS-API)—Part 301: Common Information Model (CIM) Base (International Electrotechnical Commission, 2021).
- 5 RDF Primer: <https://www.w3.org/TR/rdf-primer/> (accessed June 2022).
- 6 Common Information Model Primer (Electric Power Research Institute, 2021) 7th ed.
- 7 European Demonstration of CIM-Based Products (Electric Power Research Institute, 2006).
- 8 Transformer Modeling in the Common Information Model (Electric Power Research Institute, 2010).
- 9 A. de Vos, S. E. Widergren, and J. Zhu: Proc. 2001 IEEE Int. Conf. Power Industry Computer Applications (IEEE, 2001) 31–37.
- 10 Y. Li, Y. Li, X. Bao, and N. Tang: Proc. 2020 IEEE 3rd Int. Conf. Electronics and Communication Engineering (IEEE, 2020) 216–222.
- 11 G. M. Huang and N.-K. C. Nair: Proc. 2003 IEEE Power Engineering Society General Meeting (IEEE, 2003) 1081–1086.
- 12 C. Chakraborty, H. H.-C. Iu, and D. D.-C. Lu: IEEE Trans. Ind. Electron. **62** (2015) 4466. <https://doi.org/10.1109/TIE.2015.2412914>
- 13 V. Miñambres-Marcos, M. Á. Guerrero-Martínez, E. Romero-Cadaval, and P. González-Castrillo: IET Renewable Power Generation **9** (2015) 236. <https://doi.org/10.1049/iet-rpg.2014.0086>
- 14 X. Su, M. A. S. Masoum, and P. Wolfs: IET Gener. Transm. Distrib. **8** (2014) 1848. <https://doi.org/10.1049/iet-gtd.2013.0841>
- 15 P. Mazumdar, P. N. Enjeti, and R. S. Balog: IEEE J. Emerging Selected Topics Power Electron. **2** (2013) 451. <https://doi.org/10.1109/JESTPE.2013.2294640>

About the Authors

Te-Tien Ku received his M.S. and Ph.D. degrees in electrical engineering from National Sun Yat-Sen University in 2006 and 2012, respectively. He is presently an associate professor at National Kaohsiung University of Science and Technology. His areas of interest are smart grids and applications to distribution systems.

Chia-Hung Lin received his B.S. degree from National Taiwan Institute of Technology in 1991, his M.S. degree from the University of Pittsburgh in 1993, and his Ph.D. degree in electrical engineering from the University of Texas at Arlington in 1997. He is presently a full professor at National Kaohsiung University of Science and Technology. His areas of interest are distribution automation and the applications of computers to power systems.

Chao-Shun Chen received his B.S. degree from National Taiwan University in 1976 and his M.S. and Ph.D. degrees in electrical engineering from the University of Texas at Arlington in 1981 and 1984, respectively. From 1984 to 1994, he was a professor of electrical engineering at National Sun Yat-Sen University. From 1989 to 1990, he was with Empros Systems International. In 1994, he became the deputy director general of Department of Kaohsiung Mass Rapid Transit. From February 1997 to July 1998, he was with National Taiwan University of Science and Technology as a professor. From August 1998 to January 2008, he was with National Sun Yat-Sen University as a professor. Since February 2008, he has been with I-Shou University as a chair professor and with National Sun Yat-Sen University as a joint professor. His major interests are in the computer control of power systems and the electrical and mechanical system integration of mass rapid transit systems.

Yih-Der Lee received his Ph.D. degree in electrical engineering from National Sun Yat-Sen University (NSYSU) in 2009. From 1998 to 2010, he was an associate technical specialist at the Southern District Waste Management Plant, Environment Protection Bureau, Kaohsiung City Government, Taiwan. In 2010, he joined the Institute of Nuclear Energy Research (INER), Atomic Energy Council, where he is currently an associate researcher responsible for developing smart grid technology. His research interests include renewable energy, microgrids, power electronics, and power system control and stability. He is a member of the IEEE.

Jheng-Lun Jiang received his degree in electrical engineering from National Kaohsiung University of Applied Sciences (KUAS), Kaohsiung, Taiwan, in 2007 and his Ph.D. degree in electrical engineering from National Taiwan University of Science and Technology (NTUST), Taipei, Taiwan, in 2013. In 2013, he joined the Institute of Nuclear Energy Research (INER), Atomic Energy Council, where he is currently an associate researcher responsible for developing smart grid technology. His research interests include renewable energy, microgrids, distribution management systems, power system control and stability, and transient analysis.

Cheng-Yu Chen received his B.S. degree in engineering science from National Cheng Kung University (NCKU), Tainan, Taiwan, in 2012. In 2015, he joined the Institute of Nuclear Energy Research (INER), Atomic Energy Council, where he is currently an assistant researcher responsible for developing geographical information system technology. His research interests include geographical information systems, distribution management systems, and system integration.

Chen-Min Chan received his B.B.A. degree in information management from Ching Yun University, Taoyuan, Taiwan, in 2003 and his M.B.A. degree in information management from Ming Chuan University, Taoyuan, Taiwan, in 2005. In 2005, he joined the Institute of Nuclear Energy Research (INER), Atomic Energy Council, where he is currently an associate engineer. His research interests include system analysis, data mining, and information retrieval.